

Texas Spatial Reference Center (proposed) TXCC CORS Survey and other THM goals



Gary Jeffress, Ph.D., RPLS
Donald Mulcare, NOAA/NGS

Greg Hauger, RPLS
Texas A&M University-Corpus Christi



Challenge

- Determining valid NAVD 88 heights for Texas CORS Antenna Reference Points.

Texas CORS Stations

(online as of September 2006)

National CORS
60 TXDoT
3 H/G Subsidence Dist.
63 Total

Co-op CORS (not plotted)
28

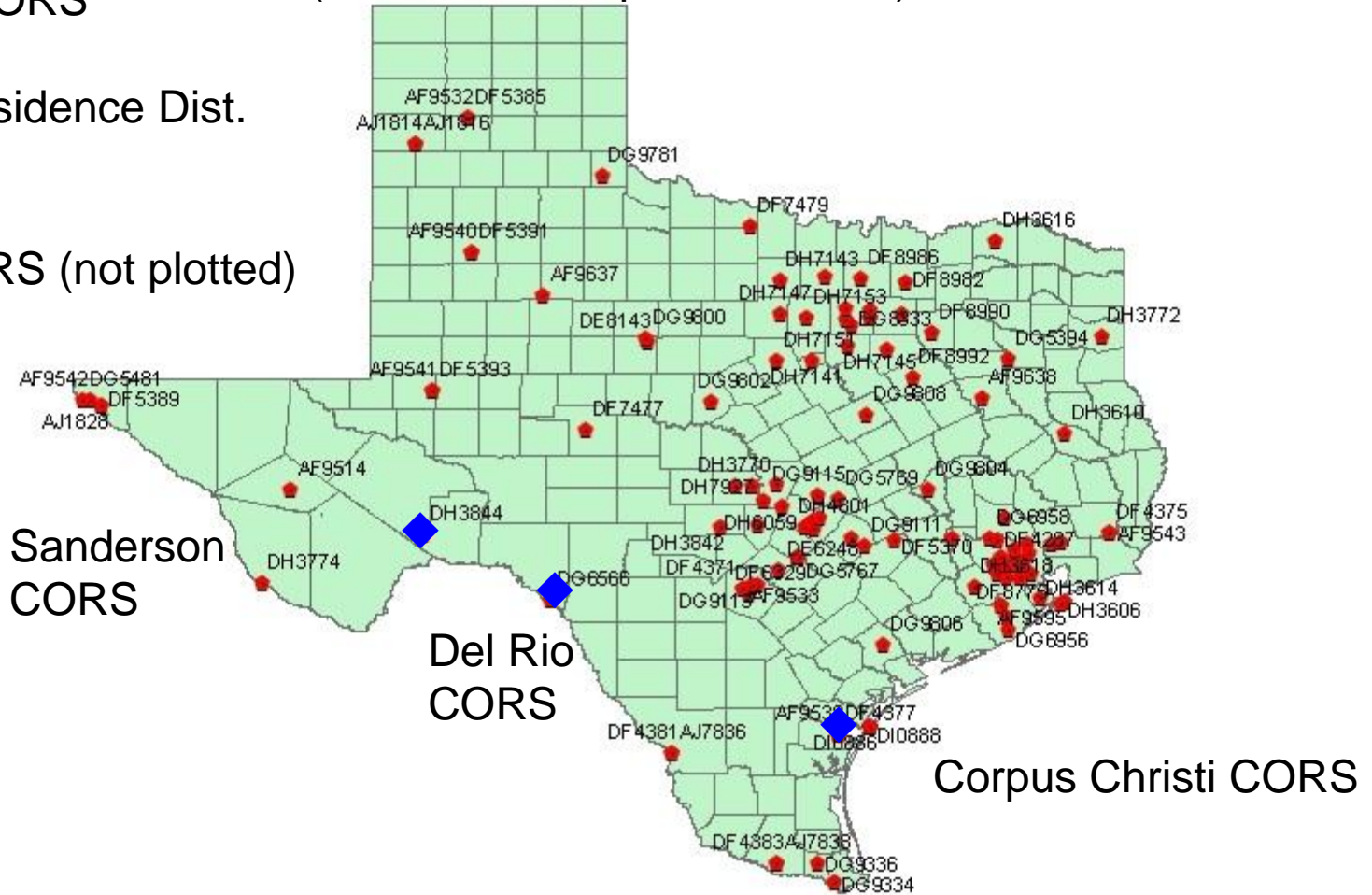

◆ Stations re-observed by Texas Height Modernization program

Texas CORS with NAVD 88

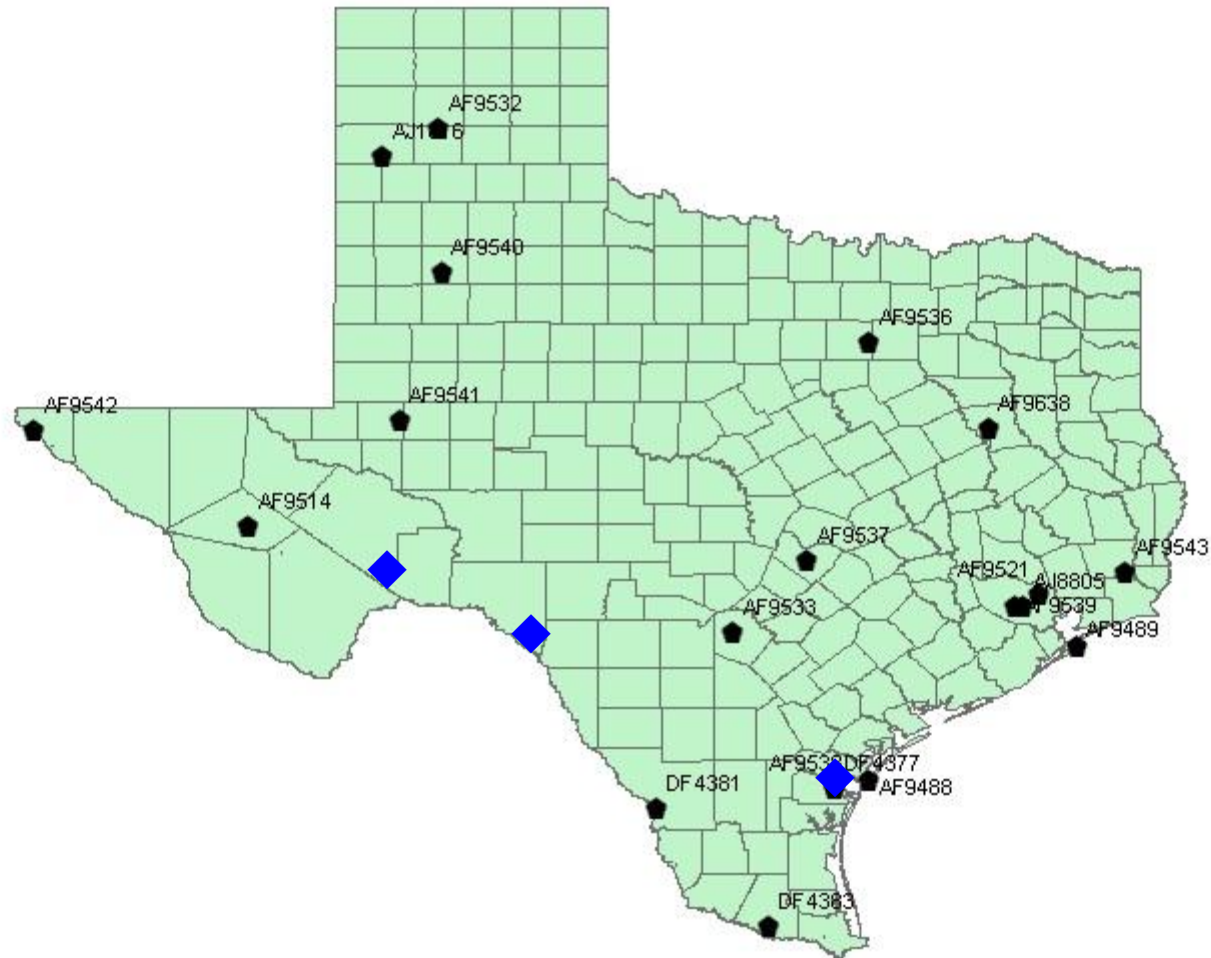

◆ Stations re-observed by Texas Height Modernization program

Connecting Corpus Christi CORS to NGVD 88

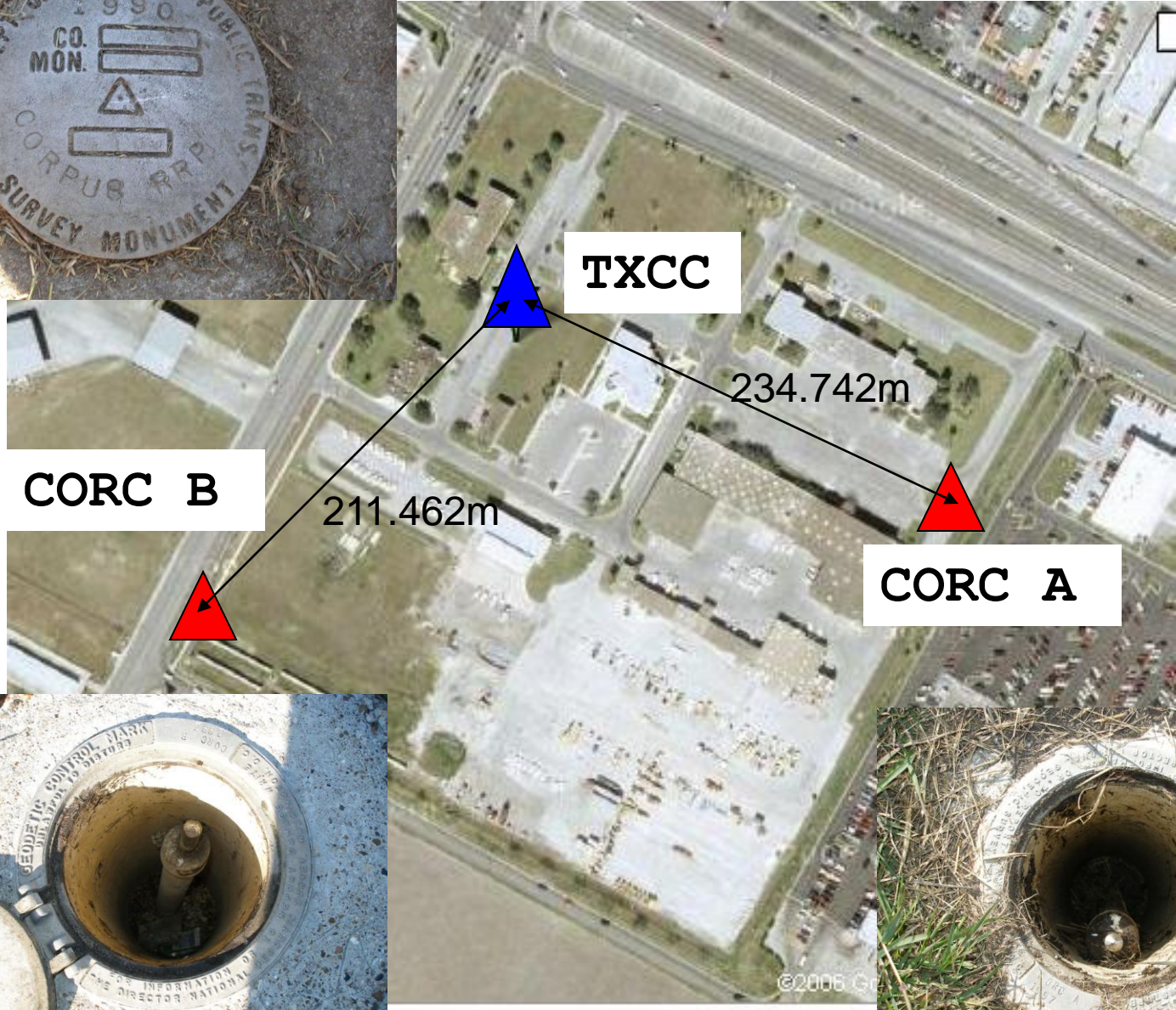



TXCC
Corpus Christi, TX

TRM 41249.00

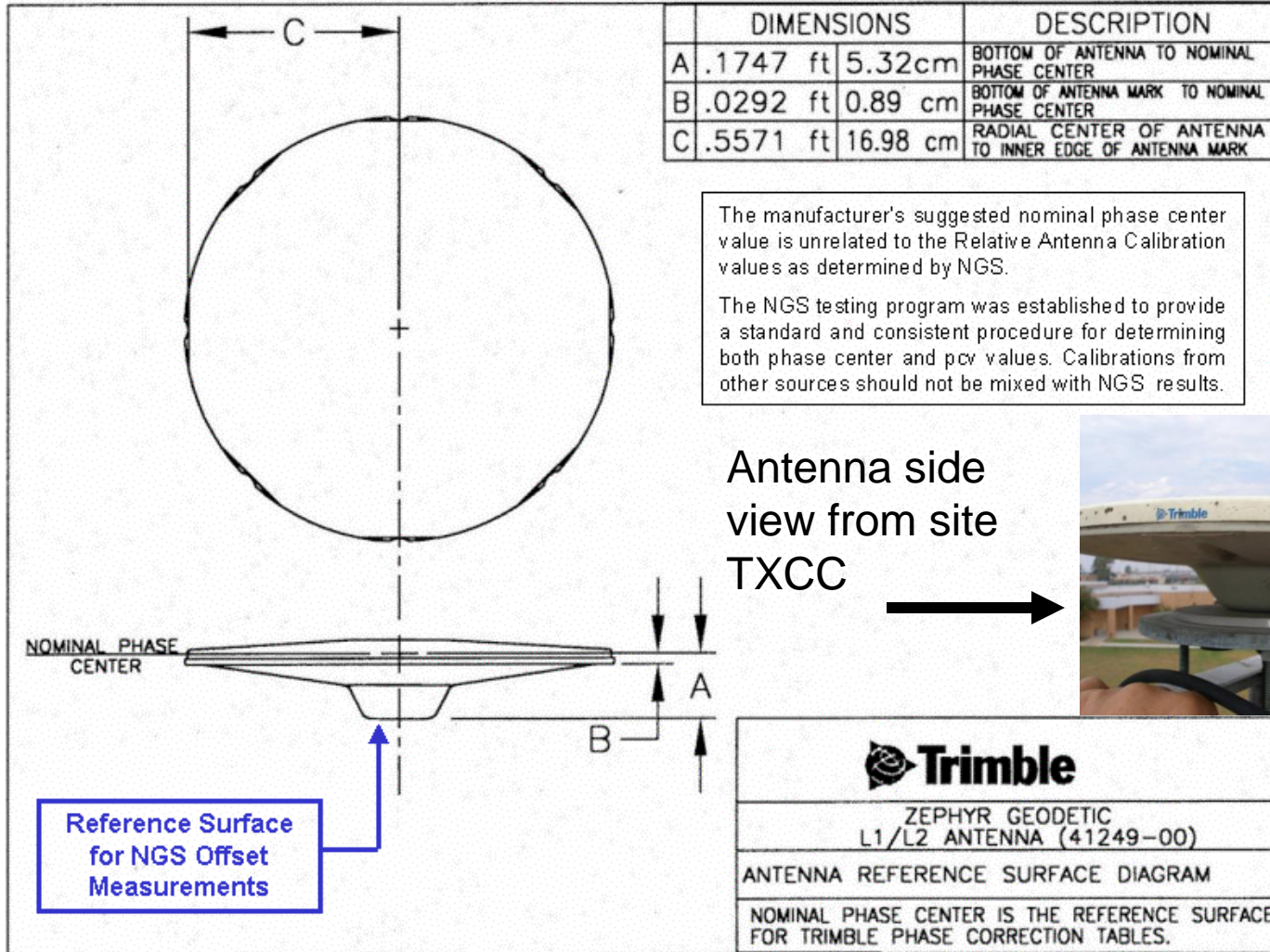

GPS Observations



- Two independent sessions were observed at first-order benchmarks located within 250 meters of the TXCC CORS site.
- All stations observed with Zephyr antennae.

PID	Designation	Horiz. Order	Vert. Ord/CL	Ellips (h) Ord/CL
AC8501	CORC A	B	1-II	4-II
AC8500	CORC B	B	1-II	4-II

GPS Session Characteristics

- Five (5) second epoch interval
- Ten (10) degree elevation mask
- Session duration minimum of four (4) hours
- Two independent sessions separated by minimum of four hours.

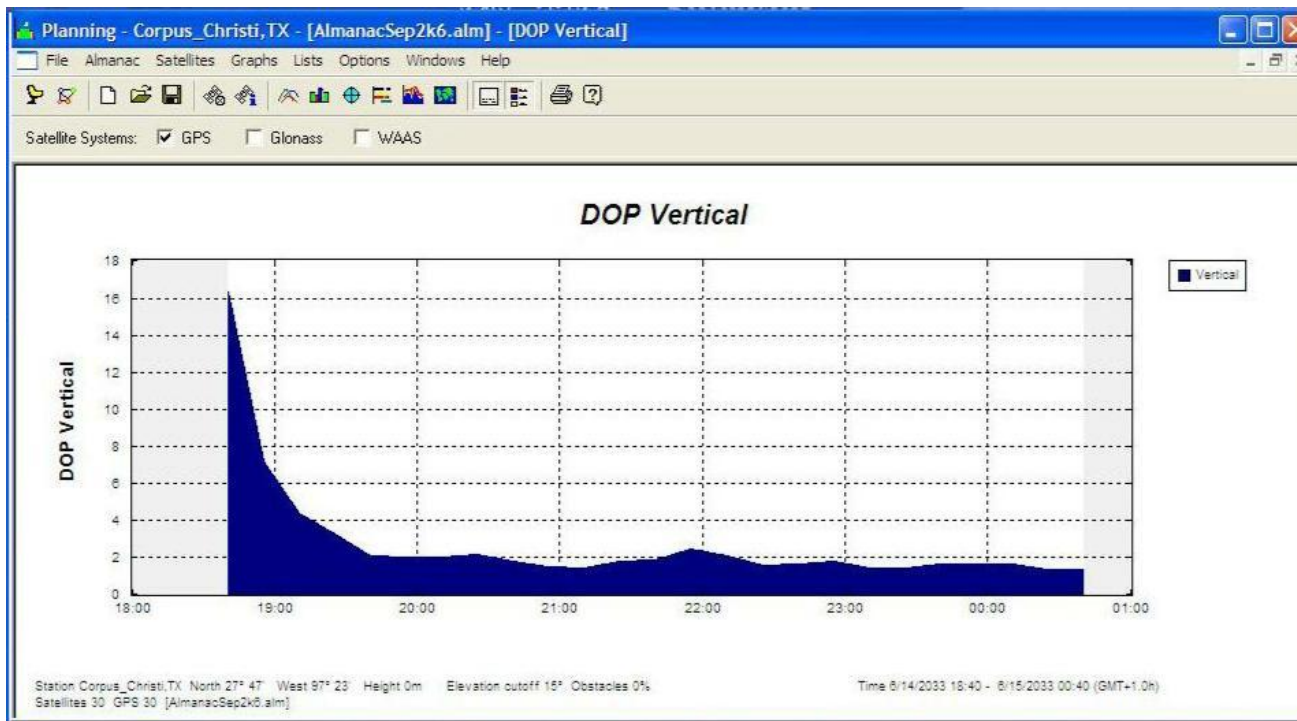

GPS Vector Reduction

- Used NGS PAGE-NT (version 0601.25) .
 - Fifteen-degree (15) elevation mask
 - Thirty-second (30) observation interval
 - IGR (rapid orbit) ephemeris used (5cm level)
 - ITRF coordinates of TXCC (from file: sitecors.bin) used as reference station
 - Tropospheric unknowns not determined due to proximity of sites to reference station
 - L1 fixed integer solution

Processing results

- Good solutions were obtained for both sessions.
 - Overall rms for solutions were 0.0081m and 0.0057 meters for days 213 and 214 respectively.
- Final solutions are fixed-integer L-1 only

GPS verification of NAVD 88 values for bench marks

- Published NAVD 88 heights for CORC A and CORC B differ by 0.248 meters.
- Minimally constrained adjustment yields a height difference of 0.252 meters (NAVD 88 comparison).
- Digital leveling difference of 0.2513 meters.
- Our GPS-derived values provide a check of 0.004 meters with published values.
 - Geoid 03 values for all three points vary from -26.357 to -26.361 (range of 0.004 m)

Corpus Christi CORS ARP

17.33 m NAVD 88 ARP (old 2002)

17.317 m NAVD 88 ARP (new 2006)
(to be published as 17.32 m)

Antenna hardware changed 2003

Conclusion

For 2cm Orthometric TM59

- 1) We have verified that GPS can yield NGS acceptable differences in height over short distances (less than 1 kilometer).
- 2) First order digital leveling between control benchmarks validates vertical relationship. This also quality checks the GPS solution for bad integer determinations or other processing defects.

Other Texas Height Modernization Project Goals

GPS on NAVD 88 Benchmarks

Observations to TM59 standards by 22 private surveyor contractors

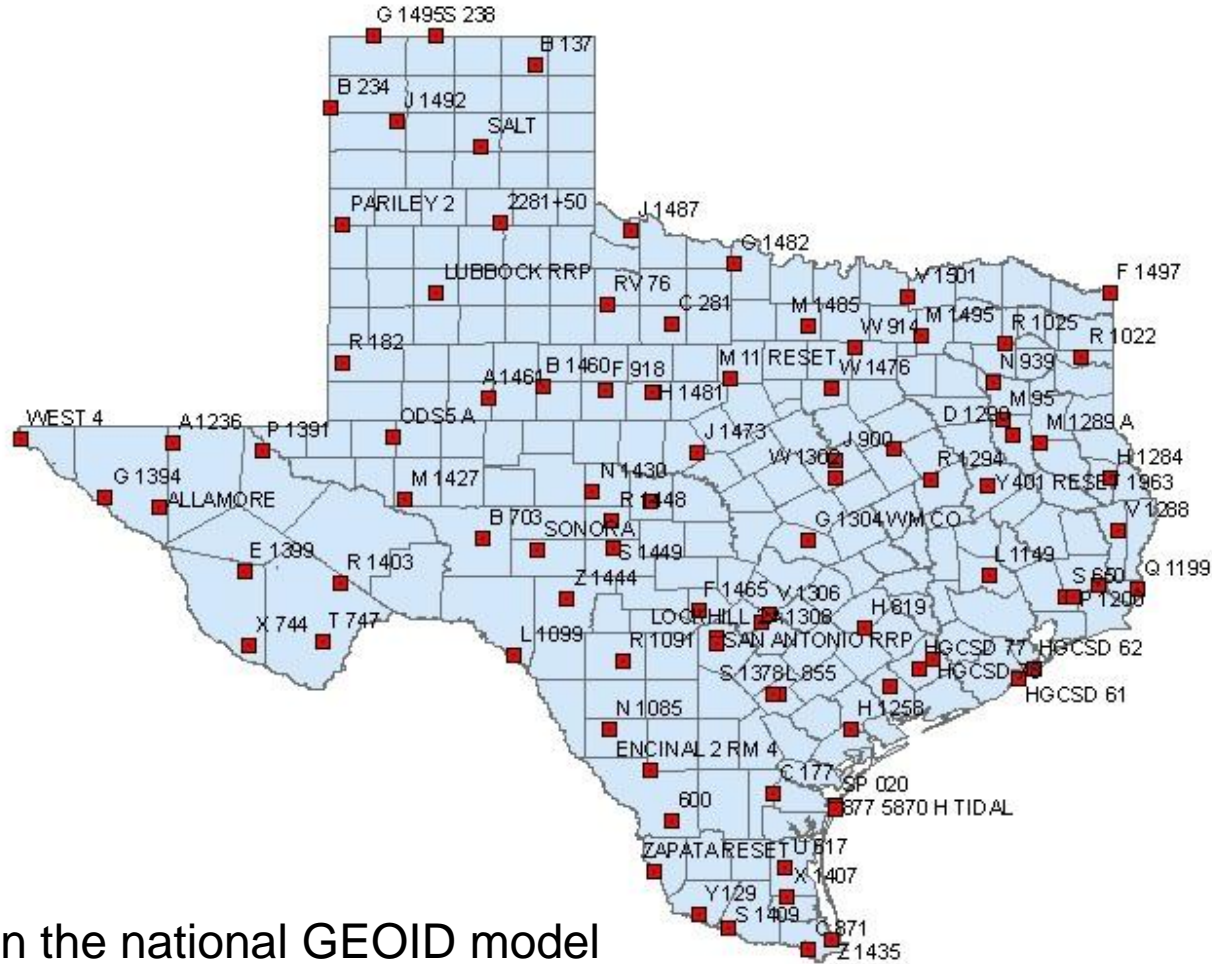

To improve in the national GEOID model

Software Development

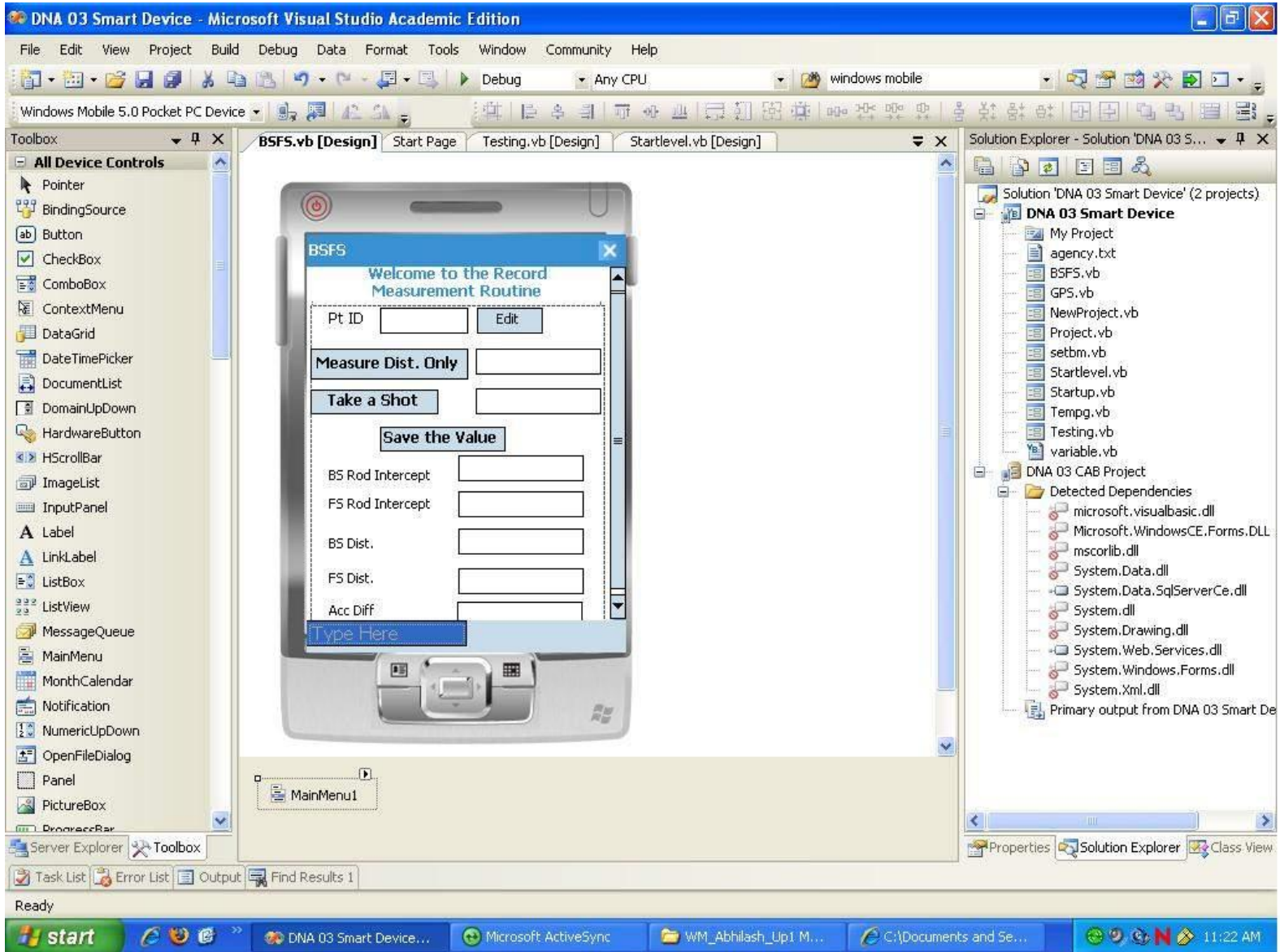

Hurricane Evacuation Route Elevation Profiling

- Perform hurricane evacuation route surveys using the Applanix Pos-LV system.
 - Applanix system allows a vehicle to log accurate 3-D data by combining GPS + inertial sensors.



CORS on NOS Tide Gauge

In cooperation with Harris-Galveston Coastal Subsidence District



NOS Gauge - Galveston Pleasure Pier

Texas Height Modernization Forum

November 15-16, 2006
JJ Pickle Research Center
Austin, Texas

<http://tsrc.tamucc.edu>

Thank you for your attention.

